

43" Superslim Freestanding Double-Sided Digital Posters

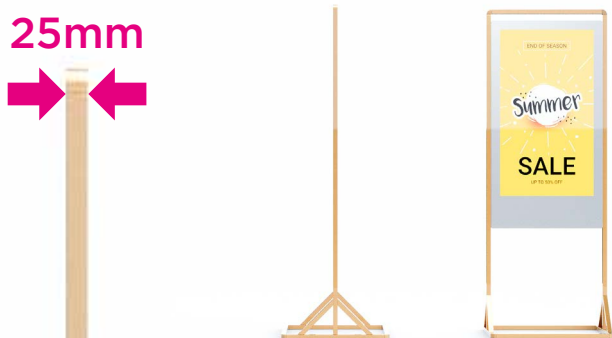

Incredibly This Dual-Sided Display









The overall depth of this display is just 25mm; thinner than most single sided displays. Not only does the exceptionally slim design attract more attention, but it also maximises manoeuvrability



Stylish Elegant Frame

With a minimalistic framework design and high-end brushed gold finish, this unique display exudes luxury and is sure to grab attention in any location.



-  Lightweight Design
-  Integrated Android Media Player
-  Premium Brushed Gold Finish
-  Ultra Resistant to Blackening Defect
-  IPS Panel
-  High Brightness Display 700cd/m²
-  Easy USB Updates
-  Network Upgrade Available
-  24/7 Commercial Grade

Other Features

Display Different Content Each Side

The special Android media player can output two separate signals simultaneously. This means that with the networked version of this product, you can display different content on each screen at the same time.

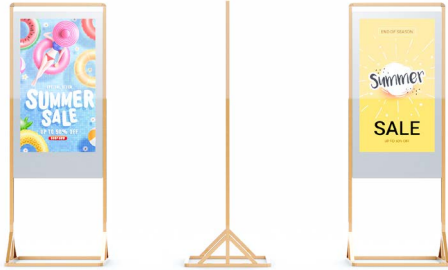

Lightweight Design

Thanks to the segmented tubular design, this freestanding digital poster can be easily moved into position, making it fully portable.



IPS Panel

Commercial grade IPS technology ensures incredible image quality and colour depth with no fall-off in colour accuracy, as well as achieving ultimate lifelike colour from an ultra-wide viewing angle in landscape or portrait orientation.



24/7 Commercial Grade

This is a true commercial grade solution. Built using high quality LCD panels and components, this solution is designed to be in constant use in public spaces.



High Brightness Displays (700cd/m²)

Both sides feature commercial grade high brightness IPS panels for accurately displaying image quality and colour depth with no fall-off in colour accuracy. These panels are designed to achieve ultimate lifelike colour temperature in portrait orientation.

Outward Facing
700cd/m²

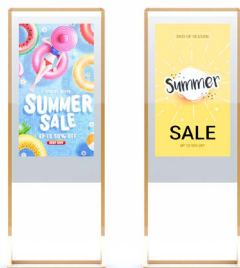

Inward Facing
700cd/m²

Integrated Android Media Player

The built in Android media player inside the screen allows you to upgrade to a network version without needing any additional hardware. You can also install third party Android apps if required.



Easy USB Updates

Plug and Play is the most straight forward way to upload content to the screen. Simply load images and videos onto a USB stick, insert into the display, wait for your content to copy over and then remove. Your images and videos will now play in a continuous loop.



Optional Network Upgrade

For a small charge you can upgrade your screen to be networked, allowing you to connect your screen via Wi-Fi, LAN or 4G, then remotely update it over the internet.

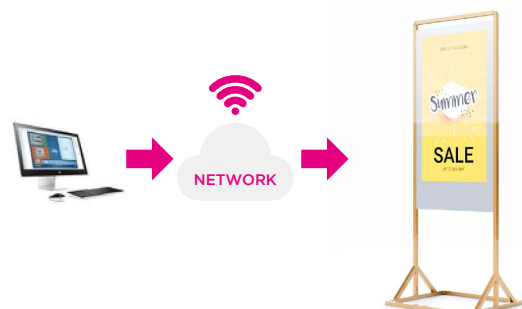

Key Features

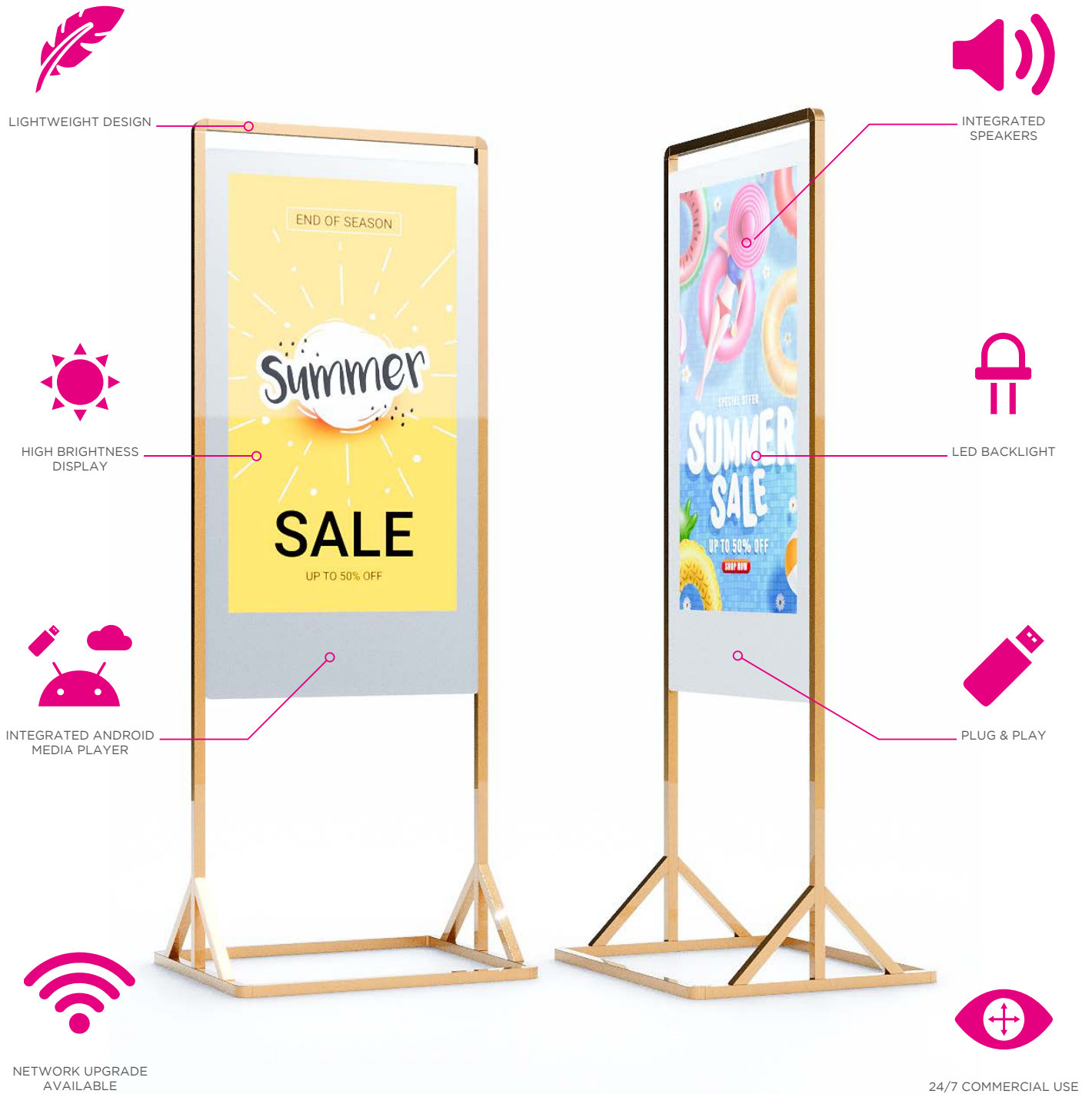

LIGHTWEIGHT DESIGN

HIGH BRIGHTNESS DISPLAY

INTEGRATED ANDROID MEDIA PLAYER

NETWORK UPGRADE AVAILABLE

INTEGRATED SPEAKERS

LED BACKLIGHT

PLUG & PLAY

24/7 COMMERCIAL USE

SUPERSLIM PROFILE
25mm



PREMIUM BRUSHED GOLD FINISH



DOUBLE SIDED DISPLAY



ULTRA RESISTANT TO SCREEN BLACKENING



Specification Table

		43 Inch
Panel	Resolution	1920x1080
	Display Area	943.2x531.4
	Aspect Ratio	16:9
	Brightness (cd/m)	700
	Colours	16.7M
	Viewing Angle	178°
	Contrast Ratio	1200:1
AV Inputs	Speaker Type	2W 8Ω (x2)
AV Inputs	Video	HDMI, VGA
	Audio	Audio Socket (3.5mm)
Power	Power Consumption (W)	150
	Input Voltage	AC100-230V (50Hz-60Hz)
Mechanical	Unit Size (WxHxD)	1840x684x50.6
	Package Size (WxHxD)	TBC
	Footprint (WxD)	684.6x600
	Net Weight (kg)	23.45
	Gross Weight (kg)	30.75
Environmental	Operating Temperature	0°C to 40°C
	Storage Temperature	-20°C - 60°C
	Operating Humidity	0% - 90%
	Storage Humidity	0% - 95%
Computer	Media Formats	Video (MPG, AVI, MP4, RM, RMVB, TS), Audio (MP3, WMA), Image (JPEG, GIF, BMP, PNG)
	Media Resolution	1920x1080/1080x1920
	CPU	Quad-Core ARM Cortex-A17 @ 1.6GHz
	GPU	Quad Core ARM Mali-T764
	RAM	2GB DDR3
	Internal Storage	8GB eMMC
	USB	1 x USB (OTG/HOST), 4 x USB (HOST)
	LAN	100M/1000M Ethernet (Network Version Only)
	Wi-Fi	802.11b/g/n/ac (Network Version Only)
	Bluetooth	Bluetooth 4.0
	OS	Android 7.1
Accessories	Graphics Engine	OpenGL ES 1.1/2.0/3.0/3.1, Open CL 1.1, Renderscript, Direct3D 11.1
	Included	Schedule Software, Remote Control, User Manual
Warranty	Optional	Network Upgrade
	Warranty Period	3 Year Warranty
	Technical Support	Lifetime

Errors and omissions excepted



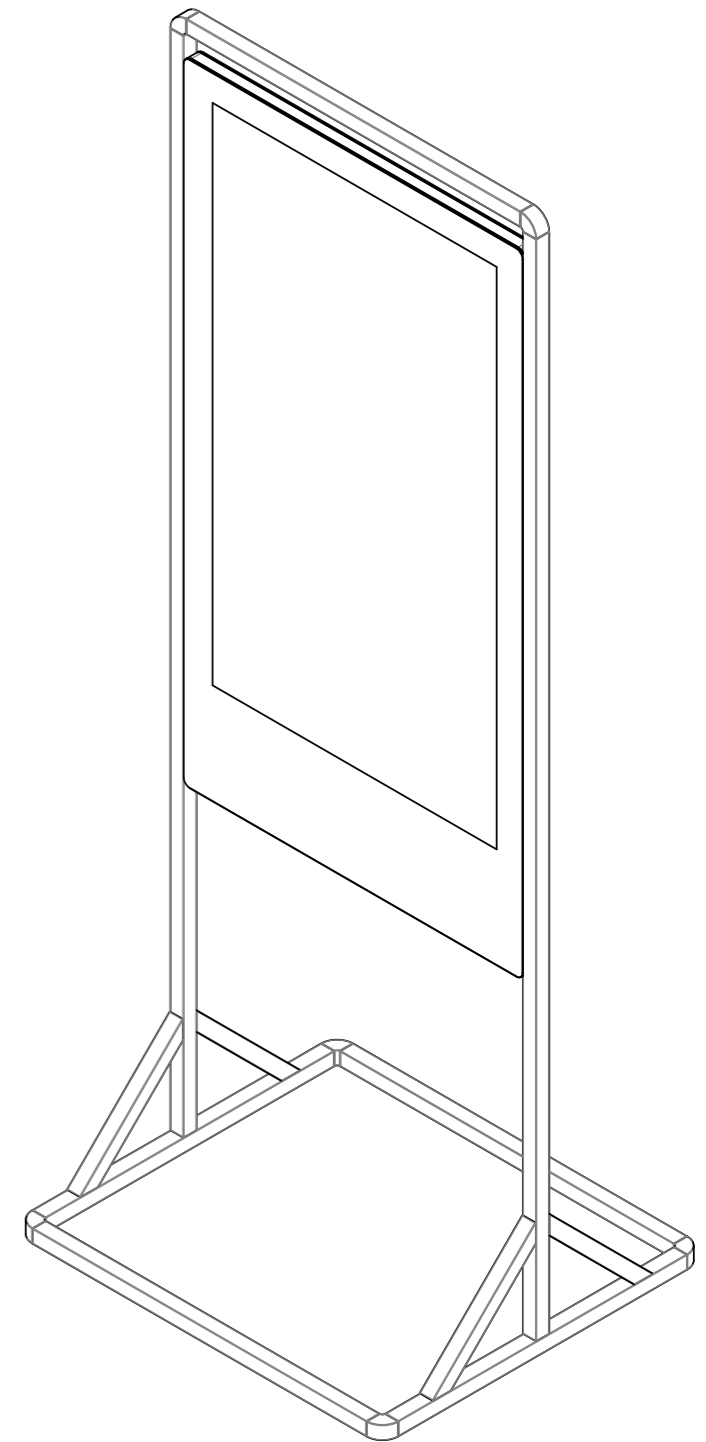
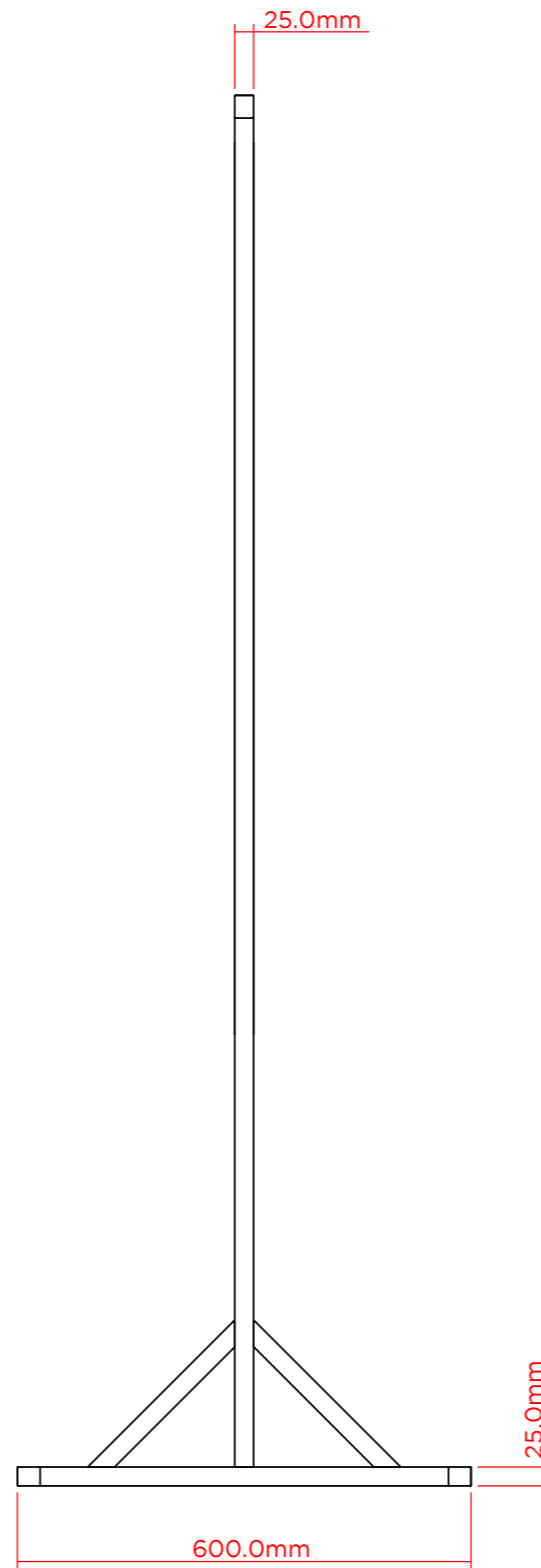
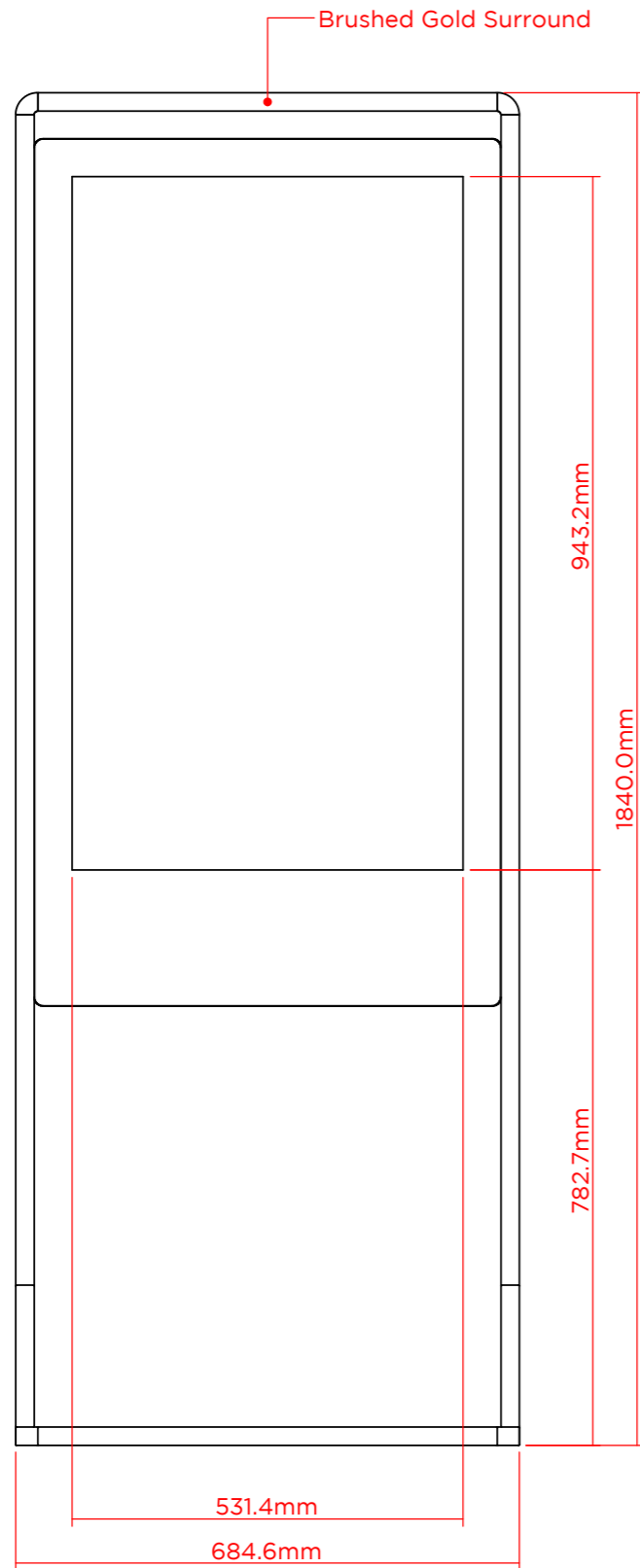

43" Superslim Freestanding Double-Sided Digital Poster Display Unit

QTY: Per Order

Client: **Signbox E-Shop**
 Job No: **AA00000/1**
 Project: **43" Superslim Freestanding Double-Sided Digital Poster Displays**
 Date / Rev: **30/10/2023 / 1**
 Scale: **1:10 @ A3**
 Drawn by: **TM**
 Site:

Notes:
 Resolution - 1920 x 1080 pixels @ 16:9 aspect ratio
 Brightness - 700 CD/m2
 Contrast Ratio - 1200:1
 Colours - 16.7M
 AV Inputs - VGA, HDMI
 Power Consumption - 150W
 Weight - 23.45Kg
 Options - Network upgrade

Colour
 Brushed Gold
 RAL 9003

Rev Date Purpose of issue
 1 30.10.23 Issued for client review

By
 AA

Approval / ISO 9001 Check	
A	Approved (initials)
B	Approved with comments
C	Not Approved
Signbox Check (initials)	

Mfg dwgs
 Complete



T: 01784 438688
E: sales@signbox.co.uk
 © signbox ltd

Why Choose Our Commercial Display Solutions?



Lifetime Technical Support

From the moment you receive your product, throughout the duration of your warranty and even after your warranty has expired we are here to support you. If you require any assistance setting up or using your product, or have any problems at all, we can provide free technical support via telephone and email.

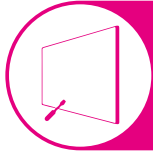

On Site Support & Maintenance*

If needed, we can provide an installation service for any of our products. We can also set up service-level agreements for larger projects that require maintenance contracts.



Extended Warranty*

All of our commercial display products come with a 3 year commercial warranty as standard but if you want to extend this you can upgrade this to cover a 5 year period at point of purchase.



Training

As well as providing free remote CMS training sessions and webinars we can also visit you to deliver bespoke training for our software and hardware*.



Advanced Replacements†

Should your display suffer from any kind of hardware failure during the warranty period we will send you an advanced replacement and arrange for your old display to be collected, free of charge. This ensures no downtime where you are without a screen.



Custom Product & Testing Configuration

If you need us to test third party software or a website, or configure your screen in a particular way before it is dispatched (e.g. in a particular orientation or network mode), we can do so to make your life easier.



3D Rendering

Want to know how a particular screen will look once installed? Send us a photo of the location and we will create a 3D rendering of any screen in situ to help you to visualise how amazing it will look.



Logistics Support

We hold more stock in our UK warehouse than any other manufacturer so we can help you meet tight deadlines. For last minute orders we can also offer special express or morning delivery options*. We also carry out UK based quality control checks on every display before it leaves our warehouse.



Project Support

If you need to loan a sample unit to test we'd be more than happy to arrange this. We can also provide a rental service for temporary projects*.



Customisation*

Your display can be customised to suit your requirements by adding your logo or printed graphics or even tailoring the colour of a display. We can also carry out hardware modifications to existing products or manufacture bespoke solutions for special projects.



Extras*

As well as being able to provide accessories and add-ons, such as extra remote controls, NUC PCs and video wall controllers, we can also supply custom made flight cases which are great if a display needs to be moved safely from place to place.

†UK mainland only
*These particular services may incur additional charges